

DRAWMER



CONTENTS

Warranty	3
Safety Consideration	3
Radio Frequencies Statement	3
<i>Chapter 1 - Introduction</i>	
Introduction	4
Installation	6
Power Connection	7
Portable Appliance Testing	7
Audio Connection	8
Typical Connection Guide	9
<i>Chapter 2 - Control Description</i>	
Control Description Intro	10
MC2.1 Controls	10
Mix Checking Tips	14
<i>Chapter 3 - General Information</i>	
If a fault develops	15
Contacting Drawmer	15
Specification	15
Block Diagram	16

COPYRIGHT

This manual is copyrighted © 2015 by Drawmer Electronics Ltd. With all rights reserved. Under copyright laws, no part of this publication may be reproduced, transmitted, stored in a retrieval system or translated into any language in any form by any means, mechanical, optical, electronic, recording, or otherwise, without the written permission of Drawmer Electronics Ltd.

ONE YEAR LIMITED WARRANTY

Drawmer Electronics Ltd., warrants the Drawmer MC1.1 Monitor Pre-Amp to conform substantially to the specifications of this manual for a period of one year from the original date of purchase when used in accordance with the specifications detailed in this manual. In the case of a valid warranty claim, your sole and exclusive remedy and Drawmer's entire liability under any theory of liability will be to, at Drawmer's discretion, repair or replace the product without charge, or, if not possible, to refund the purchase price to you. This warranty is not transferable. It applies only to the original purchaser of the product.

For warranty service please call your local Drawmer dealer. Alternatively call Drawmer Electronics Ltd. at +44 (0)1709 527574. Then ship the defective product, with transportation and insurance charges pre-paid, to Drawmer Electronics Ltd., Coleman Street, Parkgate, Rotherham, S62 6EL UK. Write the RA number in large letters in a prominent position on the shipping box. Enclose your name, address, telephone number, copy of the original sales invoice and a detailed description of the problem. Drawmer will not accept responsibility for loss or damage during transit.

This warranty is void if the product has been damaged by misuse, modification, unauthorised repair or installed with other equipment that proved to be faulty.

THIS WARRANTY IS IN LIEU OF ALL WARRANTIES, WHETHER ORAL OR WRITTEN, EXPRESSED, IMPLIED OR STATUTORY. DRAWMER MAKES NO OTHER WARRANTY EITHER EXPRESS OR IMPLIED, INCLUDING, WITHOUT LIMITATION, ANY IMPLIED WARRANTIES OF MERCHANTABILITY, FITNESS FOR A PARTICULAR PURPOSE, OR NON-INFRINGEMENT. PURCHASER'S SOLE AND EXCLUSIVE REMEDY UNDER THIS WARRANTY SHALL BE REPAIR OR REPLACEMENT AS SPECIFIED HEREIN.

IN NO EVENT WILL DRAWMER ELECTRONICS LTD. BE LIABLE FOR ANY DIRECT, INDIRECT, SPECIAL, INCIDENTAL OR CONSEQUENTIAL DAMAGES RESULTING FROM ANY DEFECT IN THE PRODUCT, INCLUDING LOST PROFITS, DAMAGE TO PROPERTY, AND, TO THE EXTENT PERMITTED BY LAW, DAMAGE FOR PERSONAL INJURY, EVEN IF DRAWMER HAS BEEN ADVISED OF THE POSSIBILITY OF SUCH DAMAGES.

Some states and specific countries do not allow the exclusion of implied warranties or limitations on how long an implied warranty may last, so the above limitations may not apply to you. This warranty gives you specific legal rights. You may have additional rights that vary from state to state, and country to country.

For the USA

FEDERAL COMMUNICATIONS COMMISSION RADIO FREQUENCY INTERFERENCE STATEMENT

This equipment has been tested and found to comply with the limits for a Class B digital device, pursuant to Part 15 of the FCC Rules. These limits are designed to provide reasonable protection against harmful interference in a residential installation. This equipment generates, uses and can radiate radio frequency energy and, if not installed and used in accordance with the instructions, may cause harmful interference to radio communications. However, there is no guarantee that interference will not occur in a particular installation. If this equipment does cause interference to radio or television reception, which can be determined by turning the equipment off an on, then the user is encouraged to try to correct the interference by one or more of the following measures:

- Re-orient or relocate the receiving antenna.
- Increase the separation between the equipment and the receiver.
- Connect the equipment into an outlet on a circuit different from that to which the receiver is connected.
- Consult the dealer or an experienced radio/TV technician for help.

Unauthorised changes or modification to this system can void the users' authority to operate this equipment. This equipment requires shielded interface cables in order to meet FCC class B limit.

For Canada

CLASS B NOTICE

This digital apparatus does not exceed the Class B limits for radio noise emissions set out in the Radio Interference Regulations of the Canadian Department of Communications.

CLASSE B AVIS

Cet appareil numérique ne dépasse pas les limites de la classe B au niveau des émissions de bruits radioélectriques fixés dans le Règlement des signaux parasites par le ministère Canadien des Communications.

SAFETY CONSIDERATIONS

CAUTION - SERVICING

DO NOT OPEN. REFER ALL SERVICING TO QUALIFIED SERVICE PERSONNEL.

WARNING

TO REDUCE RISK OF FIRE/ELECTRIC SHOCK DO NOT EXPOSE THIS EQUIPMENT TO MOISTURE.

WARNING

DO NOT ATTEMPT TO CHANGE OR TAMPER WITH THE SUPPLIED MAINS CABLES.

WARNING

TO REDUCE THE RISK OF FIRE REPLACE THE MAINS FUSES ONLY WITH A FUSE THAT CONFORMS TO IEC127-2. 250 VOLT WORKING, TIME DELAY TYPE AND BODY SIZE OF 20mm x 5mm. THE MAINS INPUT FUSE MUST BE RATED AT T315mA at 115V and T160mA at 315V.

In the interests of product development, Drawmer reserve the right to modify or improve specifications of this product at any time, without prior notice.

MC1.1 Monitor Pre-Amp

Hot on the heels of the renowned Drawmer MC2.1 comes its sibling, the MC1.1 Monitor Pre-Amplifier. Offering the same fantastic transparent and non-colouring sound but with a revised feature set more suitable for a less complex post production booth or home hifi use where multiple speaker setups are not required.



Not only has the MC1.1 been developed with the serious musician and engineer in mind, allowing you to monitor your personal workstation with complete accuracy, transparency and the ability to faithfully reproduce what has been recorded, the MC1.1 has also been designed for music lovers. As well as being able to connect your MP3 player, iPod or smartphone, you can also enjoy the warmth that only vinyl brings via the integrated RIAA phono stage. It takes just seconds - connect a turntable and active speakers or headphones to bring your vinyl collection to life.





Main Features:

- Ultra low noise and transparent circuit design. Linear power supply with low hum toroidal transformer and internal voltage selector switch.
- Three input sources, professional quality Balanced XLR, stereo 3.5mm MP3 jack and RCA switchable between line and Phono (RIAA)
- Two switchable output stages, Balanced XLR and RCA
- Mono Sub woofer output available simultaneous to balanced outs.
- Independent volume amplifier & control for headphone section.
- Features an intergrated phono stage so you can connect a turntable directly without the need for an extra box.
- Quad interleaved parallel pots for excellent Left/Right channel matching.
- Time delay relays on line outputs for clean power up/down.
- Rugged steel chassis and stylish black brushed aluminium cover. Can be stacked and is rack mountable (using optional 2U mounting kit).
- Dimensions: L 250mm x W 210mm x H 82mm. Unboxed weight 2.5kg
- Designed and manufactured by Drawmer in the UK.

INSTALLATION

The MC1.1 is a free standing, desktop unit, with controls and headphone jacks on the front panel and all other inputs and outputs on the rear. Multiple units can be stacked whilst sitting on the desk, however, the MC1.1 can be screwed to the desk or into a standard 19" rack (using a 2U mounting kit).

Screwing the MC1.1 to a desk.

Rather than having the MC1.1 free standing it can be fastened down to a desk by utilising the holes that hold the rubber feet to the underside.

Drill four holes into the desk, at 4mm in diameter and to the dimensions as shown in the diagram. (Note that the diagram is viewed from above).

Pushing four screws through the under-side of the desk screw the MC1.1, including the rubber feet, to the panel to secure. The screws should be M3 and have a length of 14mm plus the thickness of the panel.

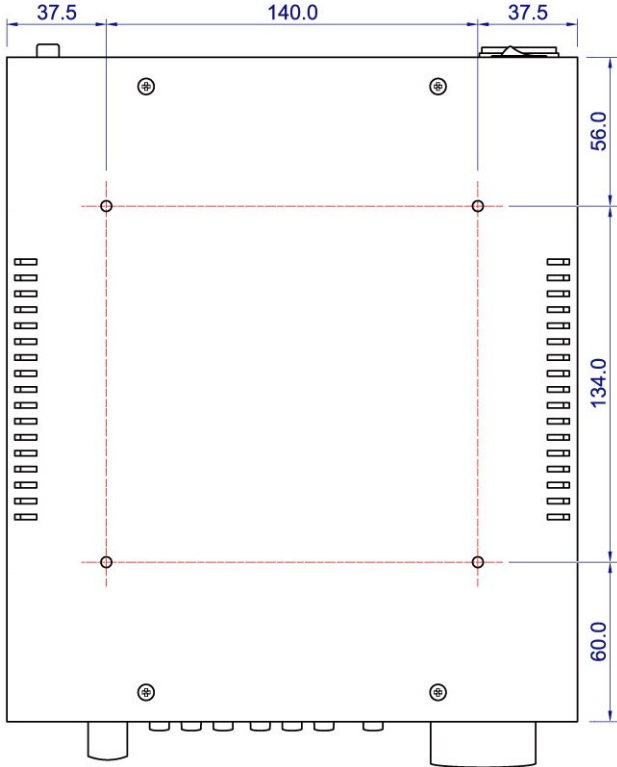

Should the MC1.1 be fitted into a rack using the optional 2U rack mounting kit, where possible, avoid mounting the unit directly above power amplifiers or power supplies that radiate significant amounts of heat.

If the unit is to be used in a mobile situation, it is strongly recommended that the rear of the unit is supported in the carrying rack to avoid bending the front panel rack mounting 'ears'. Use fibre or plastic washers to prevent the front panel becoming marked by the mounting bolts. Always connect the mains earth to the unit.

POWER CONNECTION

The MC1.1 unit will be supplied with a power cable suitable for domestic power outlets in your country. For your own safety, it is important that you use this cable to connect to the mains supply earth. The cable must not be tampered with or modified.

The power supply socket has an integral fuse drawer containing the power fuse of the same value, to suit the mains voltage for which the unit has been supplied. Removal of the drawer is only possible with the power cord removed. The fuse should never blow under normal operation. If the fuse is suspected of having blown, then a fault will have occurred and this fault condition should be inspected by a qualified service engineer. When replacing the fuse, always comply with the Safety Instructions.

If the unit is to be used with a mains input operating voltage different to that for which the unit is supplied, the following procedure must be carried out by a technically competent person:

- 1: Disconnect the unit from the mains.
- 2: Using a number 1 size pozidrive screwdriver, remove the eight screws that retain the top cover. Two screws are found along each side and four on the top.
- 3: With the cover removed slide the voltage change-over switch (**S14**) until the correct (or nearest) mains input voltage is visible on the switch actuator. The switch is located to the top right of the main circuit board between the mains I.E.C. and toroidal transformer.

For conversion to 115Volt AC (previously set to 230Volt AC).....

4a: Exchange the 160mA fuse below the mains socket for a similar type rated at 315mA

For conversion to 230Volt AC (previously set to 115Volt AC).....

4b: Exchange the 315mA fuse below the mains socket for a similar type rated at 160mA

In all cases:

- 5: Replace the top cover using the eight screws.
- 6: Re-connect to mains power source.



PORTABLE APPLIANCE TESTING

To undergo a Portable Appliance Testing procedure (commonly known as "PAT", "PAT Inspection" or "PAT Testing") use any one of the screws that hold the feet to the bottom of the unit. These screws connect directly to the chassis and provide the earthing point. If required, the foot can be removed and the cavity probed, or the screw can be replaced for something more suited to the job, such as a spade terminal with a M3 thread.

AUDIO CONNECTIONS

XLR - OUTPUT (MALE)

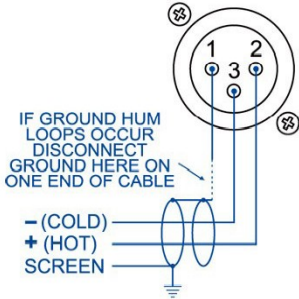

XLR - INPUT (FEMALE)

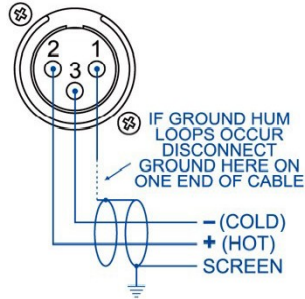

1/4" JACK - BALANCED MONO

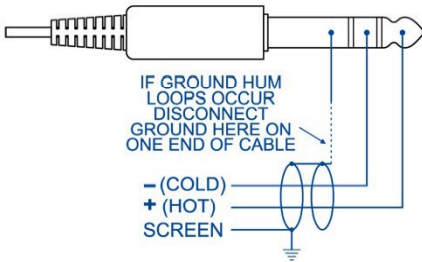

1/4" TALK BACK JACK - UNBALANCED MONO

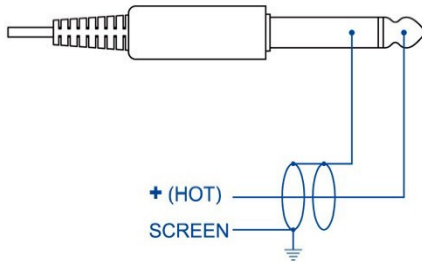

RCA (PHONO) JACK

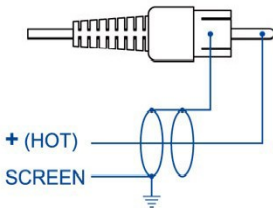

3.5mm HEADPHONE JACK

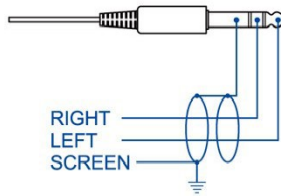

- Interference:
If the unit is to be used where it may be exposed to high levels of disturbance such as found close to a TV or radio transmitter, we advise that the unit is operated in a balanced configuration. The screens of the signal cables should be connected to the chassis connection on the XLR connector as opposed to connecting to pin 1. The MC2.1 conforms to the EMC standards.
- Ground Loops:
If ground loop problems are encountered, never disconnect the mains earth, but instead, try disconnecting the signal screen on one end of each of the cables connecting the outputs of the MC2.1 to the patchbay. If such measures are necessary, balanced operation is recommended.

TYPICAL CONNECTION GUIDE

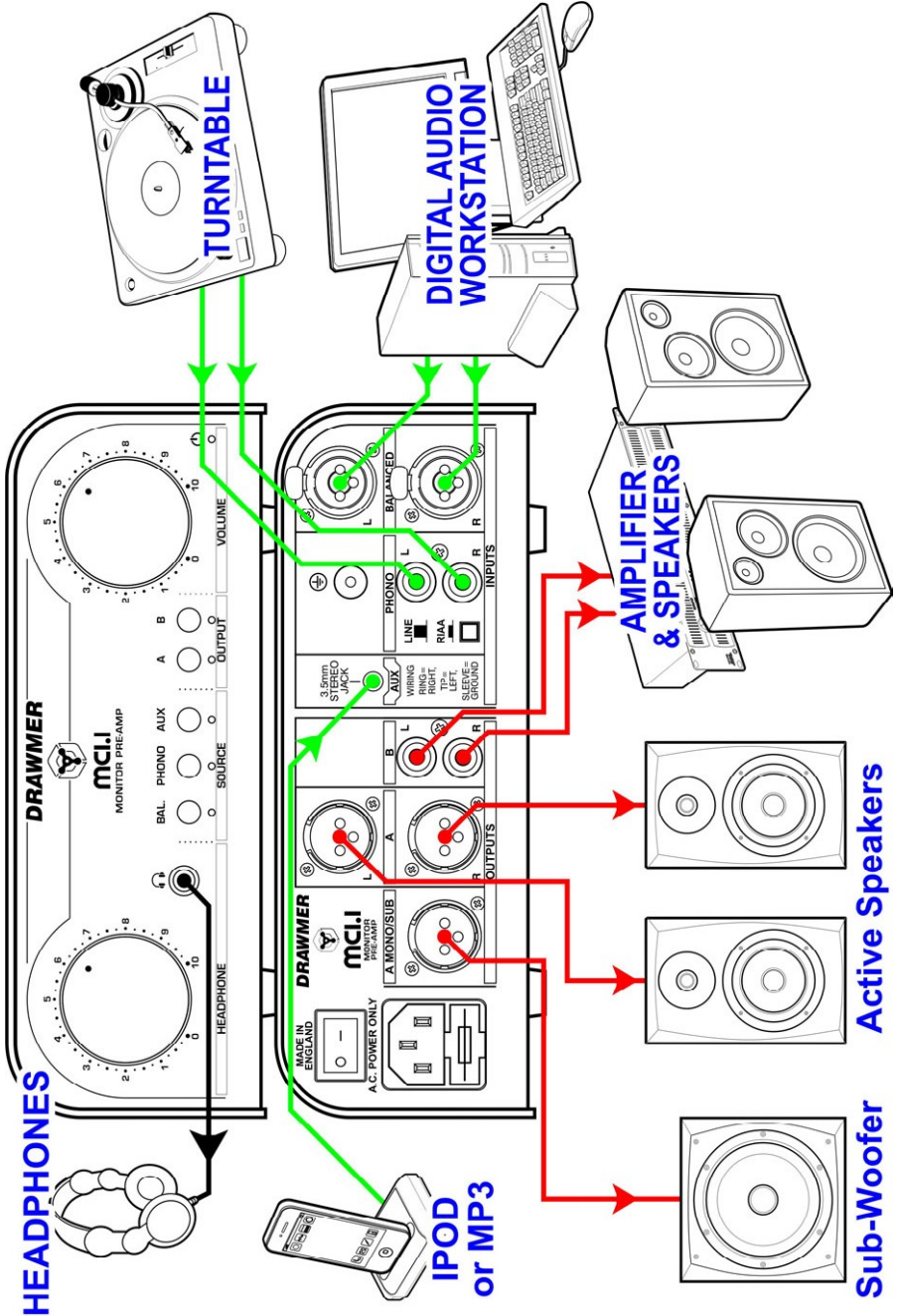

CONTROL DESCRIPTION

As well as a transparent and precise signal path clean the MC1.1 Monitor Pre-Amp has a very intuitive and functional layout. The front panel is dominated by the two large, independent volume controls for the main line outputs and the independent headphone amplifier, both incorporate a paralleled custom quad pot for excellent channel matching and the smoothest possible action. There are also individual switches for each input source, including RIAA turntable and 3.5mm MP3 player inputs and an output section that includes a mono/sub connector alongside the balanced and RCA outputs.

**The MC1.1 Controls****① SOURCE**

Three switches select which of **BALANCED**, **PHONO** and **AUX** is heard (see **⑥**). Each can be operated individually or simultaneously and in any combination. When operated simultaneously the individual signals are summed into a single stereo signal. Note that the MC1.1 does not provide individual level trims for the inputs and so any level matching should be applied before it reaches the MC2.1.

② OUTPUT

Two switches select which of the two speaker outputs **A (plus additional mono output) balanced XLR**) or **B (unbalanced RCA)** is heard (see **⑦**).

Each switch can be operated individually or simultaneously and in any combination and is perfect for performing A/B comparisons between various monitor setups. As the switches do not toggle between outputs when doing A/B comparisons both of those switches should be pressed at the same time, with A active press both the A and B switches to swap the output to B active, and then again to return to the previous setting.

An additional benefit is derived when using a sub-bass. If the sub-bass is attached to output A, delivering the lower frequencies, output B could deliver the higher frequencies and allow for A/B (or in this case A+Sub) comparisons between the two monitor setups by activating the B switch and leaving A always active.

3 MONITOR VOLUME

The Monitor Volume control adjusts the signal level of both stereo channels for all speaker outputs. The Volume knob affects the volume of the monitors A (plus the mono) & B only and does not have a bearing on the headphones. 4

The volume knob circuit design incorporates a paralleled custom quad potentiometer, for excellent channel matching and a smooth feel, with a range from Off (-infinity) to +6dB of gain.

Because the circuitry is active it allows for the signal level to be increased, unlike some devices that can only attenuated, making subtle problems within a mix (such as noise at low levels, or unwanted harmonics, for example) more obvious and easier to iron out, especially during musical passages that would normally be quiet.

WARNING:

It is recommended that you turn the volume control down to a lower level before turning the MC1.1 off - this is to ensure that a sudden volume increase when turning on does not damage your speakers or your hearing

In addition, do not use excessive force at either end of the volume knob - it's size would mean that damaging the potentiometer is possible.

4 HEADPHONES

The MC1.1 has a dedicated headphone output, via 1/4" TRS jack, with individual headphone amplifier and level control - Note that the level control is not affected by the main large monitor volume knob 3, and have no bearing on volume of the rear panel outputs 7.

Just like the main volume control the headphone knob circuit design incorporates a paralleled custom quad potentiometer, for excellent channel matching and a smooth feel across the entire rotation.

Warning:

It is advisable to unplug the headphones before switching the MC1.1 on or off. It is also recommended that you turn the headphone level down before inserting the jack, and turn it up to your desired listening level - these measures will not only prevent your ears from being damaged but also the headphone's drivers. Also, note that these are high quality circuits and have been designed for professional headphones, so care must be taken when using lower standard, consumer quality headphones, such as earbuds or ipod phones etc, as damage could occur.

5 POWER LED

A lit 2mm LED indicates that the unit is switched on. To turn the MC1.1 on see the mains input section 8.

DRAWMER



6 INPUTS

The MC1.1 has three inputs comprising:

BAL. - Left and Right balanced Neutrik XLR/jack combi (combining a 3 pole XLR receptacle and ¼" phone jack in one XLR housing),

Phono - Left and Right RCA connectors plus an Earth terminal, switchable between LINE and RIAA, and

AUX. - a 3.5mm stereo jack - for use with an iPod, MP3 player or smartphone.

Each input is activated by the **Source** switches (see 1)

The Phono RCA connectors are switchable between Line and RIAA, meaning you could connect a media palyer, cd player, tuner etc. or a turntable. The MC1.1 has a built in phono stage for use with turntables that are fitted with moving-magnet (MM) or high output Moving Coil (MC) type cartridges - this should be connected to the phono connectors with the switch set to 'RIAA'.

If the turntable has a ground wire, connect it to the Ground terminal, above. However, with some turntables, connecting the ground wire may cause hum, in which case it should be disconnected.

Standard low output Moving Coil cartridge types cannot be directly connected and will require a seperate MC phono preamplifier - this should be connected to the phono connectors but with the switch set to 'Line'. In this case the turntable ground wire should be connected to the seperate preamplifier.

WARNING: NEVER play a standard line-level source into the PHONO input when set to RIAA. This could result in damage to the MC1.1, your amplifier or speakers due to the extra gain that is applied and would not be covered under warranty.

Note that as the MC1.1 has no individual level trims level matching will need to be controlled prior to the MC1.1.

7 OUTPUTS

Two stereo balanced speaker outputs- **A** and **B**, plus a dedicated mono speaker/sub-woofer output - **MONO** - are found on the rear of the unit. **A** and **MONO** in the form of Neutrik 3 pin XLR's and **B** utilises RCA connectors.

Each output is activated by the **Speakers** switches (see 2) - and can be activated individually or simultaneously.

If connecting the A Mono/Sub output to a subwoofer bear in mind that the stereo signal is monogised but contains the signal's full frequency range. Any low pass filtering, volume level, subsonic filtering etc. should be performed by the subwoofer itself (or external crossover box).

8 MAINS I.E.C. AND POWER SWITCH

The MC1.1 is fitted with an internal toroidal linear power supply to provide low amounts of hum and a professional level of headroom.

The mains inlet, I.E.C., which also incorporates the internal mains fuse, can be found on the rear of the unit. A mains lead will have been provided with the MC1.1 to suit the mains configuration for the country of your purchase.

The power switch is located above the I.E.C. and is used to switch the unit on and off. This is a hard boot switch (as opposed to a soft stand-by switch) and so when in the off position the MC1.1 will draw no mains power.

Note that a timed relay protection circuit has been incorporated into the MC1.1 to prevent bangs and other potentially harmful artifacts from occurring during power up and power down.

Mix Checking Tips

As well as sitting next to your turntable as a great hifi preamp the MC1.1 works as a simple monitor controller that can do a few tasks to help check your mix.

The following are a few handy tips to help eradicate problems and bring about a balance within the mix:

Not too loud...

Give your ears a break. Do not have the volume too loud - frequent monitoring at anything above 90dB will only make your ears tired, meaning that you won't really hear the problems that may be occurring, and give you a false sense that the mix sounds nice and loud. Also, constant listening at anything above 100dB will probably have a long term detrimental effect on your hearing.

Shhhh...

Get into a habit of listening to your mix at very low levels quite often. Remember that not everyone listening to your song has music blasting out. As well as giving your ears a break, it will heighten problems in the mix - Do the key elements have a good balance, or are some instruments more prominent than they should be? If something is too quiet or loud adjust its volume or use E.Q. to fix it. If the mix sounds good at low levels it's likely that it will when loud.

Increase the Volume of Quiet Passages.

Because the MC1.1 circuitry is active it allows for the signal level to be increased, rather than only attenuated, making subtle problems within the mix, such as noise at low levels, or unwanted harmonics, more obvious and easier to iron out, especially during passages that would normally be quiet.

Here, There and Everywhere.....

Listen to your mix on as many systems as possible. The two monitor outputs allows for the addition of a non standard testing setup i.e. the system could be forced to emulate low-quality domestic reproduction systems as well as car speakers or a portable radio, by incorporating limited-bandwidth speakers to output B. In such conditions you may find that an instrument drops out of the mix, or another is too prominent, and adjustment to the mix need to be made. For best results calibrate the speakers to match the output level of the rest of the system.

MC2.1 GENERAL INFORMATION**IF A FAULT DEVELOPS**

For warranty service please call Drawmer Electronics Ltd. or their nearest authorised service facility, giving full details of the difficulty. A list of all main dealers can be found on the Drawmer webpages. On receipt of this information, service or shipping instructions will be forwarded to you.

No equipment should be returned under the warranty without prior consent from Drawmer or their authorised representative.

For service claims under the warranty agreement a service Returns Authorisation (RA) number will be issued. Write this RA number in large letters in a prominent position on the shipping box. Enclose your name, address, telephone number, copy of the original sales invoice and a detailed description of the problem.

Authorised returns should be prepaid and must be insured.

All Drawmer products are packaged in specially designed containers for protection. If the unit is to be returned, the original container must be used. If this container is not available, then the equipment should be packaged in substantial shock-proof material, capable of withstanding the handling for the transit.

CONTACTING DRAWMER

We will be pleased to answer all application questions to enhance your usage of Drawmer equipment.

Please address correspondence to:

DRAWMER Electronics LTD
Coleman Street
Parkgate
Rotherham
South Yorkshire
S62 6EL
United Kingdom

Telephone: **+44 (0) 1709 527574**
Fax: **+44 (0) 1709 526871**

Contact via E-mail: **tech@drawmer.com**

Further information on all Drawmer products, dealers, Authorised service departments and other contact information can be found on our website: **www.drawmer.com**

SPECIFICATION

Note: These specifications are provisional and may alter slightly upon product release.

INPUT

Maximum Input Level 21dBu

OUTPUT

Maximum Output Level
before clipping 21dBu

DYNAMIC RANGE

@ unity gain 118dB

CROSSTALK

L/R @ 1kHz >85dB

THD & NOISE

unity gain 0dBu input
0,0014%

FREQUENCY RESPONSE

20Hz-20kHz +/- 0.2dB

PHASE RESPONSE

20Hz-20kHz +/- 2degrees max

POWER REQUIREMENTS

115V or 230V at 50-60Hz, 20VA
Voltage set by internal voltage switch

FUSE RATING

@ 115V T315mA
@ 230V T160mA
Conforming to IEC 127-2

FUSE TYPE

20mm x 5mm, Class 3 Slo-Blo,
250Volt working

CASE SIZE

Depth (with Controls
& Sockets) 272mm
Width 215mm
Height (with Feet) 81mm

WEIGHT

2.5kg

BLOCK DIAGRAM

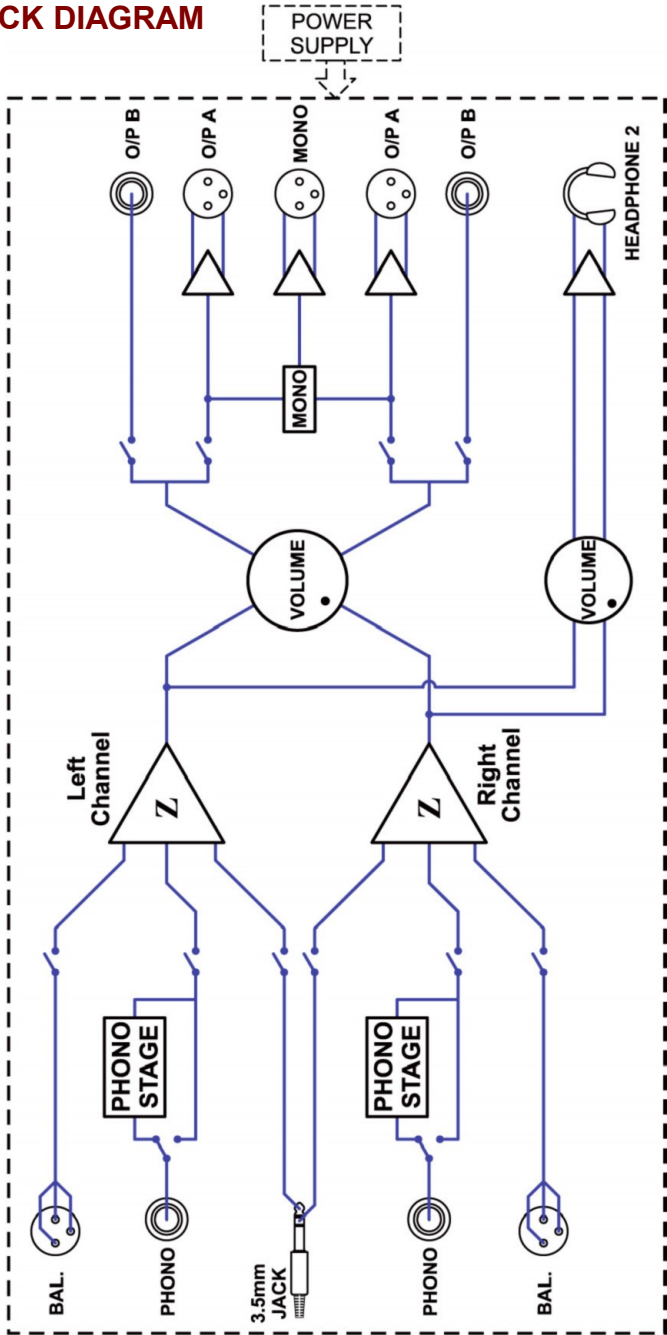

Ref:1v01A 13-05-15